

**RKF** 3-, 4-, 5- and 8-Pole

Micro (M12), Receptacle, 3-, 4-, 5-, and 8-pole, Female for front mounting, 24 and 22 AWG, panel mount thread PG9, IP 68 and NEMA 6P rated.

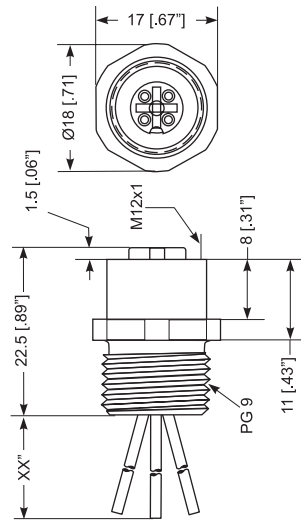

**RSF** 3-, 4-, 5- and 8-Pole

Micro (M12), Receptacle, 3-, 4-, 5-, and 8-pole, Male for front mounting, 24 and 22 AWG, panel mount thread PG9, IP 68 and NEMA 6P rated.

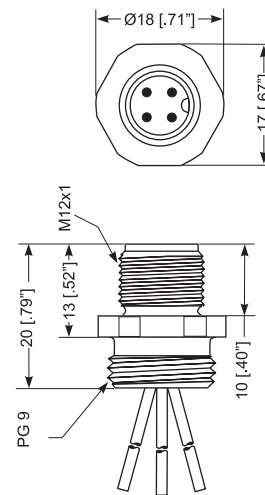

**Pin Assignment**

**Micro (M12) Female / Male**

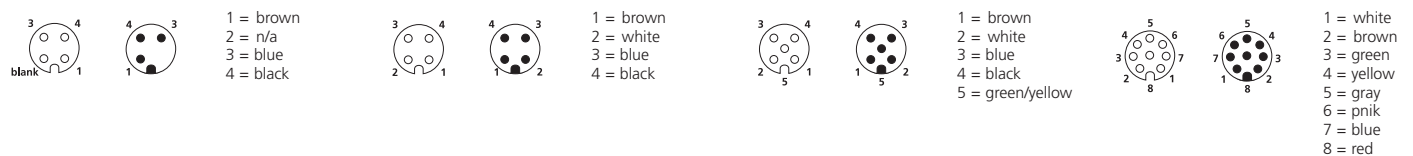

<b>Technical Data</b>	
Degree of protection	IP 68 / NEMA 6P
Operating temperature range	-25°C (-13°F) / +90°C (+194°F)
<b>Mechanical</b>	
Housing	Brass, nickel-plated
Insert	PUR, black (female) 3-, 4- and 5-Pole: Nylon (male) 8-Pole: PUR, black (male)
Contact	Brass, gold over nickel-plated
<b>Electrical</b>	
Voltage rating	3-5 Pole: 250 V 8 Pole: 30 V / 36 V DC
Current rating	3-5 Pole: 4 A 8 Pole: 1.5 A
<b>Accessories</b>	Panel nut (RSKF 9)







Mini

Micro (M12)

Micro (1/2"-20)

Pico (M8)

Din Valve  
Connectors

Part Number		Poles	
RKF 4-3/0.5M	RSF 3/0.5M	3	 
RKF 4/0.5M	RSF 4/0.5M	4	 
RKF 5/0.5M	RSF 5/0.5M	5	 
RKF 8/0.5M	RSF 8/0.5M	8	

References