

Circular Connectors (EC-CC)

Artikelnummer A712-7S10400000

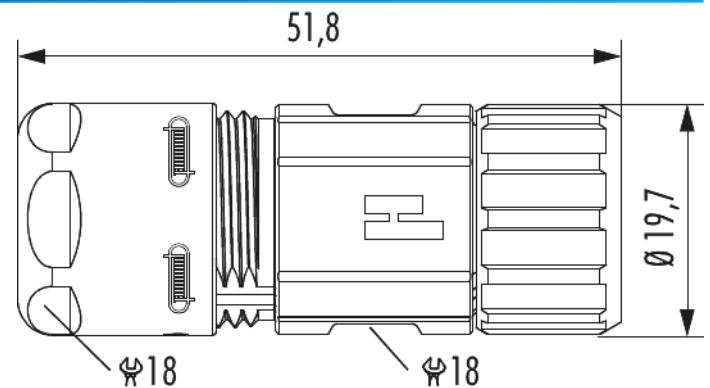

Technische Daten

Material Gehäuse	Messing, Zink-Druckguss
Material Gehäuseoberfläche	vernickelt
Kodierung	S, T
Material Dichtungen/O-Ringe	HNBR, NBR
Schlüsselweite (SW1/SW2)	18/18 mm
Kabeldurchmesser	5 - 9 mm
Temperaturbereich	-40°C bis +125°C
Schutzart	IP 67, IP 69 K

Kaufmännische Daten

Verpackungseinheit	5
EAN-Code	4033878505458
Gewicht (Stammdaten)	0,04788 kg
ETIM 7	EC003556
eCl@ss 10.1	27440224

Circular Connectors (EC-CC)

Artikelnummer A712-7S10400000

Notiz:

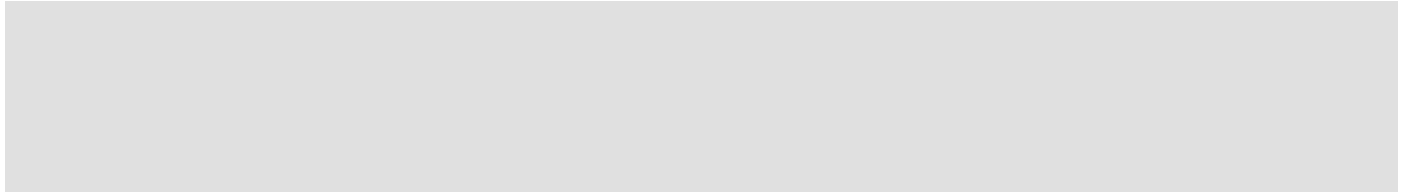

Circular Connectors (EC-CC)

Artikelnummer A712-7S10400000