

Circular Connectors (EC-CC)

Artikelnummer A712-7K30500000

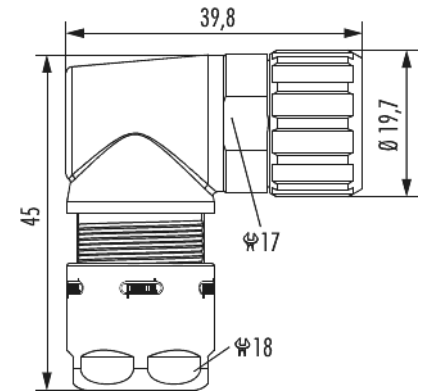

Technische Daten

Material Gehäuse	Messing, Zink-Druckguss
Material Gehäuseoberfläche	vernickelt
Material Dichtungen/O-Ringe	HNBR, NBR
Kabeldurchmesser	8 - 11 mm
Temperaturbereich	-40°C bis +125°C
Schutzart	IP 67, IP 69 K

Kaufmännische Daten

Verpackungseinheit	5
Gewicht (Stammdaten)	0,06252 kg
ETIM 7	EC003556
eCl@ss 10.1	27440224

Notiz:

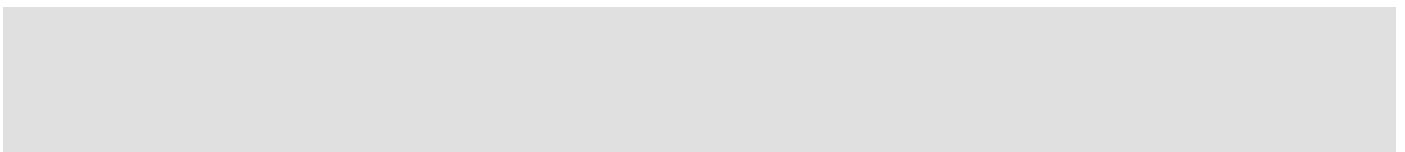

Circular Connectors (EC-CC)

Artikelnummer A712-7K30500000



Circular Connectors (EC-CC)

Artikelnummer A712-7K30500000

