

03

0314

Rundsteckverbinder mit Schraubverschluss M16 nach IEC 61076-2-106, IP40/IP67/IP68



Einbaustecker nach IEC 61076-2-106, IP68, mit
Schraubverschluss und Lötanschlüssen, für Frontmontage

03

0314

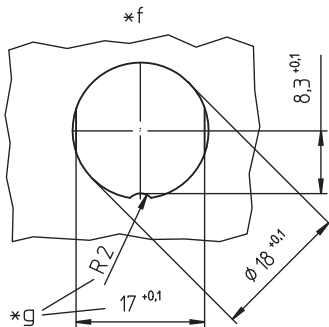
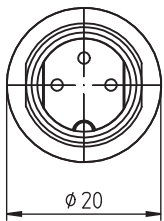
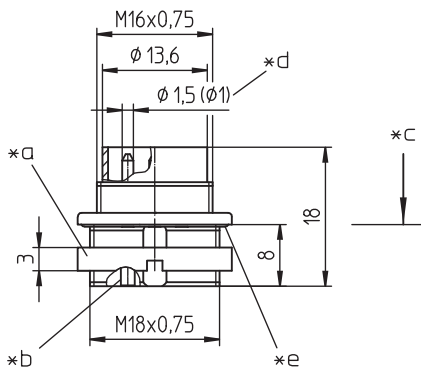
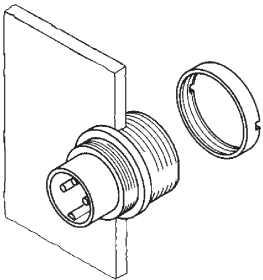

Umgebungsbedingungen

Temperaturbereich -40 °C/+85 °C

Werkstoffe

Kontaktträger	PA GF, V-0 nach UL94
Kontaktstift	CuZn, versilbert und flashvergoldet (3- bis 8-polig) CuZn, unternickelt und vergoldet (12- bis 14-polig)
Gehäuse	Zn-Druckguss, unterkupfert und vernickelt
Ringmutter	CuZn, vernickelt
Dichtung	NBR

Mechanische Daten

Anzugsdrehmoment Steckverbinder	1-3 Nm
Anzugsdrehmoment Mutter	1-3 Nm
Schutzart	IP68 ¹

¹ nach IEC DIN EN 60529, nur in verschraubtem Zustand mit einem dazugehörigen Gegenstück; IPX8-Anforderungen in Absprache zwischen Anwender und Hersteller

Anschließbare Leiter Lötanschluss

Querschnitt	≤ 0,75 mm ² (AWG 20) (3- bis 8-polig) ≤ 0,25 mm ² (AWG 24) (12- bis 14-polig)
-------------	--

Elektrische Daten (bei T_u 20 °C)

Bemessungsstrom	5 A (T _u 40 °C, 3- bis 8-polig) 3 A (T _u 40 °C, 12- bis 14-polig)
Bemessungsspannung	bei Verschmutzungsgrad 1: 300 V (Polbilder 03, 04, 05-1, 06, 07) 100 V (Polbilder 05, 07-1, 08, 08-1) 160 V (Polbilder 12, 14) bei Verschmutzungsgrad 2: 250 V (Polbilder 03, 04) 32 V (Polbilder 05, 07-1, 08, 08-1) 160 V (Polbilder 05-1, 06, 07, 12, 14)
Bemessungsstoßspannung	1500 V (Polbilder 03, 04, 05-1, 06, 07, 12, 14) 500 V (Polbilder 05, 07-1, 08, 08-1)
Isolierstoffgruppe	II (IEC)/I (UL) (400 ≤ CTI < 600)
Überspannungskategorie	I
Isolationswiderstand	> 100 MΩ

03

0314

Polbilder, von der Lötseite gesehen

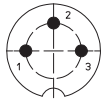

03-a
0314 03



04-a
0314 04

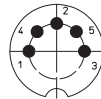

05-b
0314 05

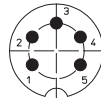

05-a
0314 05-1

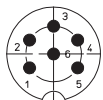

06-a
0314 06

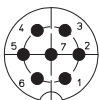

07-a
0314 07

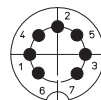

07-b
0314 07-1

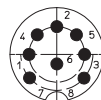

0314 08

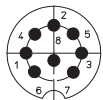

08-a
0314 08-1

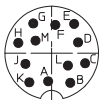



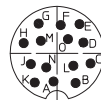



12-a
0314 12









14-a
0314 14

Zugehörige Produkte

Gegenstücke

 0321	 0322	 0322-1
 032200	 0360	 036000

Zubehör

 0382	 0383	 038399
 0384	 0385	 038899

- *a Mutter lose beigestellt
- *b Lötkelch
- *c Montagerichtung
- *d Kontaktstift
Ø 1,5 mm (0314 03–0314 08-1)
Ø 1,0 mm (0314 12–0314 14)
- *e O-Ring-Dichtung
- *f Einbauöffnung
- *g Verdrehschutz, Ausführung wahlweise

03

0314

Bestellbezeichnung	Polzahl	VE (Stück)	MDQ (Stück)
0314 03	3	50	100
0314 04	4	50	100
0314 05	5	50	100
0314 05-1	5	50	100
0314 06	6	50	100
0314 07	7	50	100
0314 07-1	7	50	100
0314 08	8	50	100
0314 08-1	8	50	100
0314 12	12	50	100
0314 14	14	50	100

Verpackung:
im Karton